

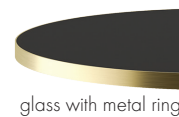

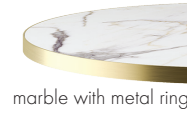



TOP OPTIONS





AVAILABLE FINISHINGS

TOP

-  Carrara Marble
-  Veneer Wood
-  Lacquered Satin Glass in RAL colour codes

STRUCTURE

-  Lacquered Metal in RAL colour codes
-  Satin Natural Brass

PRODUCT CODE **FTC8**

Model	Coffee Table
Environment	Indoor
Materials	Structure: lacquered metal in RAL colour codes. Top: veneer wood, lacquered satin glass or marble.
Optional	Base: natural brass or lacquered metal in RAL colour codes. Top: laminate finish, veneer wood or marble with or without metal ring, glass top only with metal ring.
Technical description	Round coffee table with one central leg and different top options.
Dimensions	Ø 60 cm - H 45 cm

OVERALL DIMENSIONS

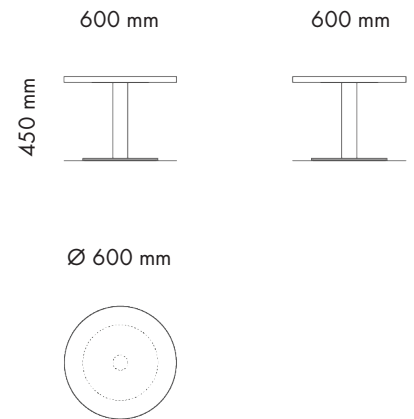

DESCRIPTION

Gilda, timeless and no-design collection of dining-, coffee- and lounge-tables, ideal for hospitality and healthcare contract.

AVAILABLE MATERIALS

Due to the nature of the product, all fabrics and finishes can be customised.
For enquiries: info@manusfactor.com