





CH5/NW CH SEATING COLLECTION

Furniture



PRODUCT CODE **CH5/NW/PC** OR **CH5/NW/WP**

AVAILABLE FINISHINGS

-  Natural beech wood
-  **CH5/NW/PC** Paper cord
-  **CH5/NW/WP** Polyester colour collection

Model	Low Stool
Environment	Indoor
Materials	Natural beech structure and woven paper or polyester cord seat.
Customisable finishes	Polyester cord colour combination.
Technical description	Handmade Chiavari low stool with woven seat.
Dimensions	W 53 cm - D 42,5 cm - H 43,5 cm
Weight	Weight: 2,2 kg

OVERALL DIMENSIONS

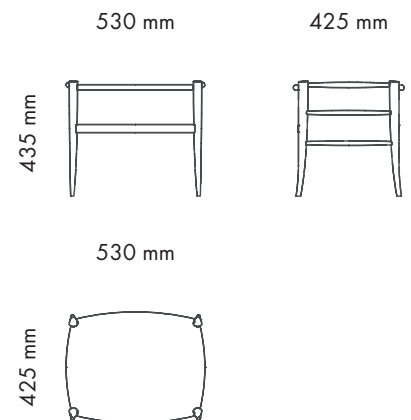

DESCRIPTION

Collection of handmade Chiavari chairs, inspired by the archetypical chair, light and resilient at the same time.

AVAILABLE POLYESTER CORD COLOUR COMBINATIONS

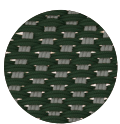

CH5/NW/WP1



CH5/NW/WP2

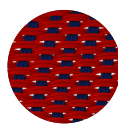

CH5/NW/WP3

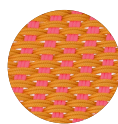

CH5/NW/WP4

AVAILABLE MATERIALS

Due to the nature of the product, all fabrics and finishes can be customised.
For enquiries: info@manusfactor.com

Due to the handcrafted nature of the product, small variations in colours, size and shape can occur.

Exclusively distributed by
www.manusfactor.com
info@manusfactor.com